



SCR Power Controller Delivers Up to 80 Amperes in a Compact Package

The DIN-A-MITE® C silicon controlled rectifier (SCR) power controller provides a low cost, compact and versatile solid state option for controlling electric heat. This controller is designed and manufactured with the quality features expected from Watlow®. DIN-rail, panel mount and through-wall mount versions are available.

Features include single-phase, three-phase/two leg, and three-phase/three leg, 24-600VAC operation. Current switching capabilities range from 30 to 80A depending on the model ordered.

Variable time-base, linear voltage and current process control or VAC/VDC input contactor versions are available. Single-phase, phase angle firing and current limiting are also available. All options are model number dependent and factory configurable. This power controller includes 200KA short circuit current rating (SCCR) tested up to 480VAC to minimize damage in the event of a short circuit when used with required fusing.

Features and Benefits

200KA SCCR with proper fusing

- Minimizes damage in the event of a short circuit

DIN-rail, panel and through-wall mounting

- Provides versatility and quick, low-cost installation

Compact size

- Reduces panel space and cost

Touch-safe terminals

- Increases safety for installer and user

One- and three-phase power

- Can be used in a variety of applications

Open heater/shorted output alarm

- Notifies the user in case of an open heater or shorted output

Mercury free

- Assures environmental safety

Faster switching with solid state

- Saves energy and extends heater life

UL® 508 listed, C-UL®, RoHS 2 and CE with filter

- Meets applications requiring agency approval
- Reduces end product documentation cost

System solution component

- Provides single source thermal loop

Back-to-back SCR design

- Ensures a rugged design

ISO 9001

Registered Company
Winona, Minnesota USA

Specifications

Operator Interface

- Control input and indication light
- Alarm output and indication light
- Current limit indication LED

Amperage Rating

- See output rating curves on the next page
- Max. surge current for 16.6ms, 1,350A peak
- Max. I²t for fusing is 9100A²s
- Latching current: 500mA max.
- Holding current: 200mA max.
- Fan current: 0.14A for 24VDC; 0.12A for 120VAC; 0.06A for 240VAC
- Off-state leakage 1mA at 77°F (25°C) max.
- Power dissipation: 1.2 watts per ampere per leg switched
- 200KA SCCR, Type 1 and 2 approved with the recommended fusing; see user manual

Line Voltage

- 24 to 48VAC units: 20.4VAC min. to 53VAC max.
- 100 to 240VAC units: 48VAC min. to 265VAC max.
- 277 to 600VAC units: 85VAC min. to 660VAC max.
- 100 to 120VAC, 200 to 208VAC, 230 to 240VAC, 277VAC, 400VAC, 480VAC, 600VAC, +10/-15%, 50 to 60Hz independent ±5% (control options L, P and S)

Alarms (zero cross models only)

Shorted SCR Alarm Option

- Alarm state when the input command signal is off and a 10A or more load current is detected by the current transformer (two turns required for 5A and three turns for 2.5A)

Open Heater Alarm Option (Control Option S only)

- Alarm state when the input command signal is on and the load current detected by the current transformer is 20% less than customer adjusted set point

Alarm Output

- Energizes on alarm, non-latching
- Triac 24 to 240VAC, external supply with a current rating of 300mA @ 77°F (25°C), 200mA @ 122°F (50°C), 100mA @ 176°F (80°C) and a holding current of 200µA with a latching current of 5mA typical

Agency Approvals

- CE with proper filter:
204/108/EC electromagnetic compatibility directive EN 61326-1:
industrial immunity Class A emissions not suitable for Class B environments
Phase angle and phase angle with current limit (control options P and L) are not CE approved for conducted or radiated emissions
- 2006/95/EC low voltage directive EN 50178 safety requirements installation category III, pollution degree 2
- UL® 50 Type 4X enclosure, Class 1, Div. 2 per ANSI/ISA 12.12.01. Through-wall heat sink models T4 File 184390
-  UL® 508 listed and C-UL® File E73741
- 2011/65/EU RoHS 2
- Shock and vibration tested to IEC 60068-2-32
- Vibration tested to IEC 60068-2-6

Control Input Terminals

- Compression: will accept 24 to 16 AWG (0.2 to 1.5 mm²) wire
- Torque to 4.4 in. lb (0.5 Nm) max. with a 1/8 in. (3.5 mm) blade screwdriver

Line and Load Terminals

- Compression: will accept 14 to 3 AWG (2.5 to 25 mm²) wire
- Torque to 24 in. lb (2.7 Nm) max. with a 1/4 in. (6.4 mm) blade screwdriver, or a type 1A, #2 Pozzi driver

Operating Environment

- See the output rating curve chart on next page
- 0 to 90% RH (relative humidity), non-condensing
- Storage temperature: -40 to 185°F (-40 to 85°C)
- Operating temperature: -29 to 176°F (-34 to 80°C)
- Insulation tested to 3,000 meters

DIN-Rail Mount

- DIN EN 50022, 35 mm by 7.5 mm

Back-Panel Mount

- Four mounting holes No. 6 to No. 8 (M3 to M4) fastener

Through-Wall Mount

- See page 4 for through-wall panel cutout (**Note:** Mount cooling fins vertically.)

Additional Specifications for Contactors and Time Proportional Controllers

Control Mode, Zero-Cross

- Control option C: VDC input, contactor output
- Control option K: VAC input, contactor output
- To increase service life on contactor models, the cycle time should be less than three seconds
- Control option F: 4 to 20mA DC input, variable time-base control output

Control Input

- AC contactor: 24VAC ±10%, 120VAC +10/-25%, 240VAC +10/-25% @ 25mA max. per controlled leg
- DC contactor: 4.5 to 32VDC: max. current @ 4.5VDC is 6mA per leg, add 2mA per LED used to the total current
- Loop powered linear current 4 to 20mA DC: loop-powered, control option F0 only (requires current source with 8.0VDC available, no more than two DIN-A-MITE inputs can be connected in series)

Additional Specifications for Phase Angle, Phase Angle with Current Limit, and Single-Cycle, Variable Time-Base

Operation

- With control option S (single-cycle, variable time-base) the output is not on for more than one consecutive AC cycle below 50% power and not off for more than one consecutive AC cycle above 50% power
- Phase angle control, single-phase only

Control Input

- 0 to 20mA, 4 to 20mA, 0 to 5VDC, 1 to 5VDC and 0 to 10VDC
- Input impedance 250Ω for 4mA to 20mA, 5kΩ for linear voltage input

Output Voltage

- 100 to 120VAC, 200 to 208VAC, 230 to 240VAC, 277VAC, 400VAC, 480VAC and 600VAC, ±10%

Linearity (Control Option S)

- ±5% input to output power over 0 to 100% of span between calibration points

Linearity (Control Options P and L)

- ±5% input to output power, as referenced to a sinusoidal power curve, between calibration points

Resolution

- Better than 0.1% of input span with respect to output change

Soft Start (Control Options P and L)

Typically:

- 5 second soft start on power up
- Soft start on thermostat over temperature
- Soft start on 1/2 cycle drop out detection
- 1 second soft start on set point change

Options

- Manual control kit (1kΩ potentiometer) 08-5362
- Alarm option is **not** available on control options P or L

Specifications are subject to change without notice.

Output Rating Curves

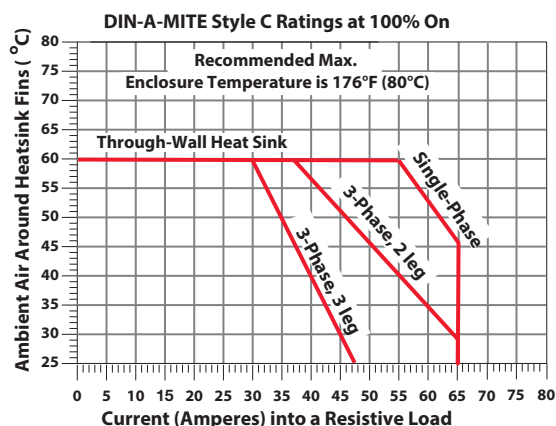
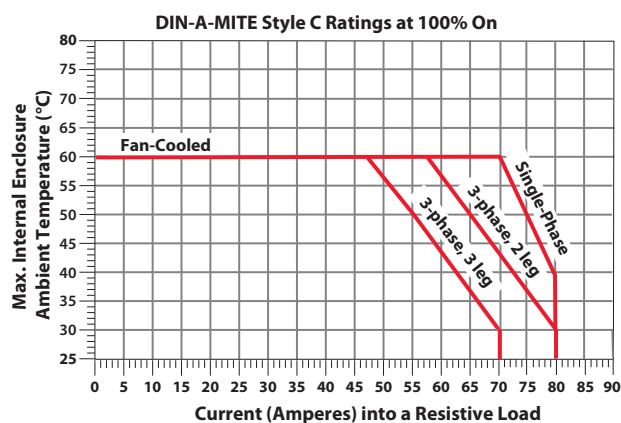
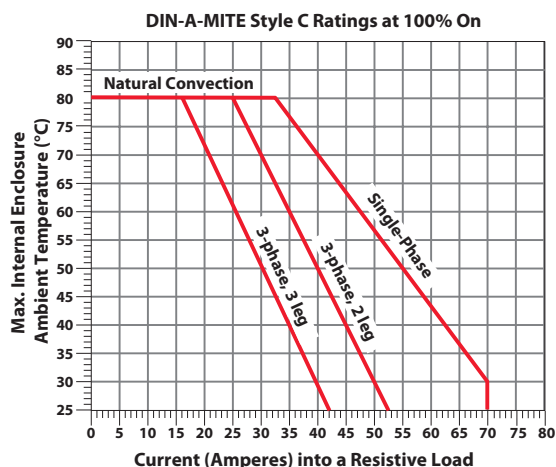

Dimensions—Natural Convection, DIN-rail/Panel Mount

Front

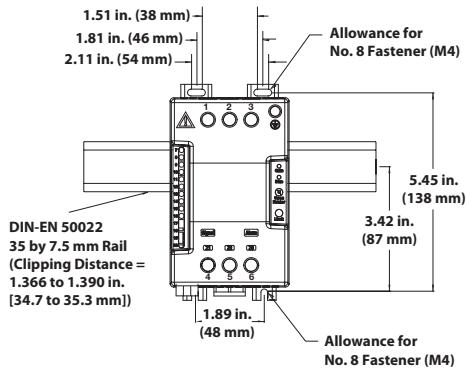

Side

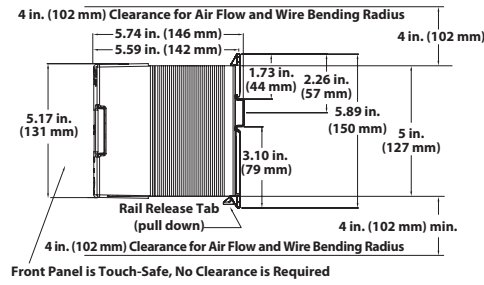

Top

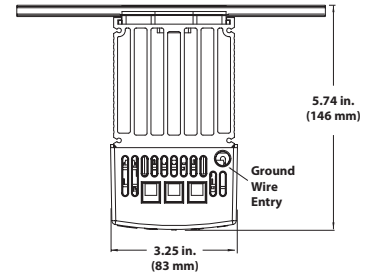

Dimensions—Fan Cooled, DIN-rail and Panel Mount

Side

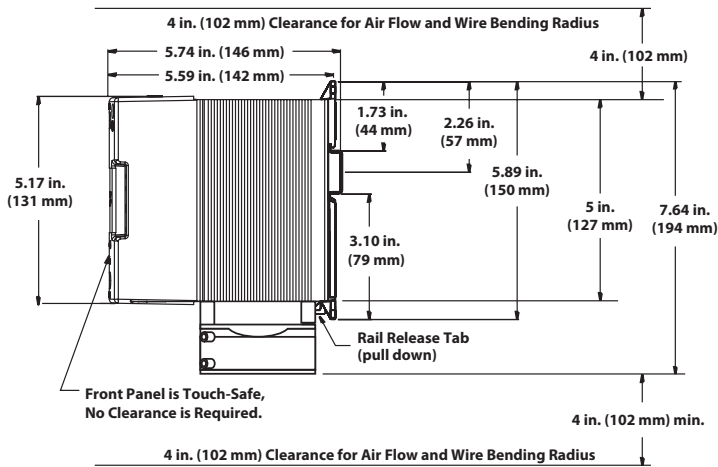

Dimensions—Natural Convection, Through-Wall Mount^①

Front

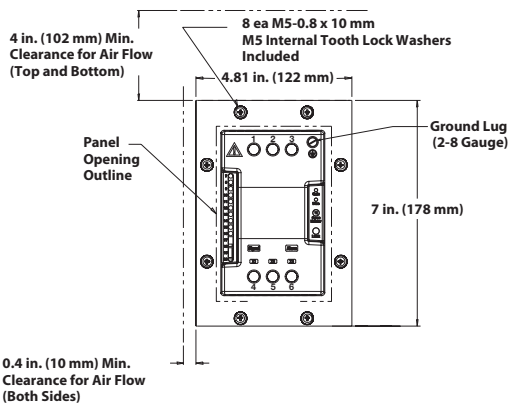

Top

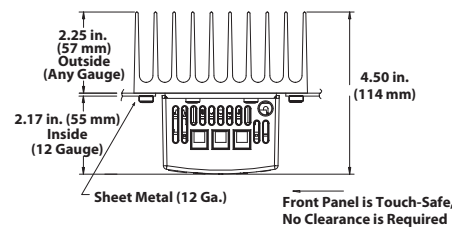

Panel Cutout

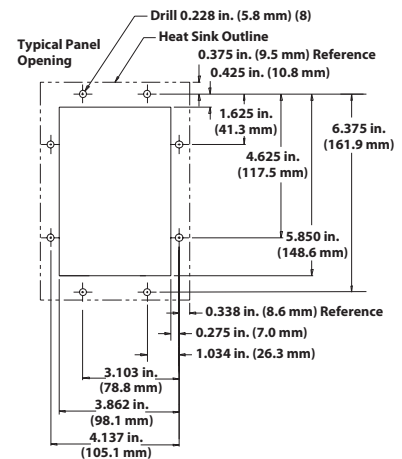

^① With the potential for high through-wall heat sink temperatures, application may require a touch-safe shield.

Extended Heater and Power Controller Life with Variable Time-Base

With variable time-base control, the power controller automatically adjusts the time-base and output power with respect to the command signal. Accelerated life testing shows that variable time-base control significantly reduces expansion and contraction of the heater element. This extends heater and power controller life while improving process temperature control. This saves money on heaters, downtime and maintenance.

Loop-Powered or Transformer Powered

Loop-Powered

By using a temperature controller's 4-20mA process output signal as the power supply for the DIN-A-MITE input, the cost of the power controller can be reduced. With control option F0 the 4-20mA control signal simultaneously powers the DIN-A-MITE's internal electronics and provides the input command signal.

Transformer-Powered

DIN-A-MITE controllers with single-cycle, variable time-base or phase angle outputs (control options L, P and S) detect the power line zero cross with a transformer that also powers their internal electronics. These units can be controlled manually with a potentiometer or automatically with a temperature controller using any of the control options: 4-20mA, linear voltage (0-5,1-5 and 0-10VDC).

Loop-Powered, Variable Time-Base Output

Models: DC__-__F0-_____

20% Power Output: 3 AC cycles on, 12 cycles off



50% Power Output: 3 AC cycles on, 3 cycles off

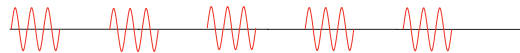

80% Power Output: 12 AC cycles on, 3 cycles off

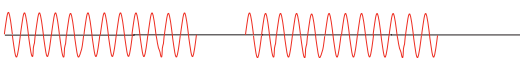

With loop-powered, variable time-base control, the minimum on or off time is three cycles.

Phase Angle Output

Models: DC1_-_-_[L, P]_-0_-_-

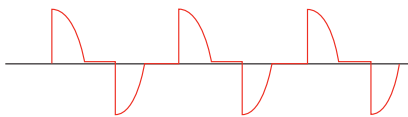

Phase angle control (control options L and P) is infinitely variable over the period of the AC sine wave. It provides a variable voltage and/or current output. The phase angle circuitry is transformer powered and accepts a linear voltage, current or potentiometer input.

Single-Cycle, Variable Time-Base Output

Models: DC__-__S_-----

25% Power Output: 1 AC cycle on, 3 cycles off

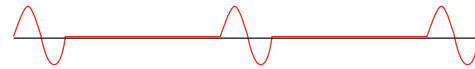

50% Power Output: 1 AC cycle on, 1 cycle off

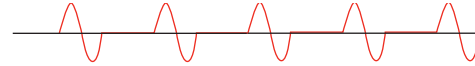

With single-cycle, variable time-base control, at 50 percent power, the output is on for one cycle and off for one cycle. At 25 percent, it is on for one cycle and off for three cycles. Under 50 percent, the output is not on for more than one consecutive cycle; over 50 percent the output is not off for more than one consecutive cycle.

Semiconductor Fuses for Applications through 600VAC

Fuse Part Number		
Fuse Rating	Watlow	Cooper Bussman®
40A	17-8040	FWP-40A14F
50A	17-8050	FWP-50A14F
63A	17-8063	FWP-63A22F
80A	17-8080	FWP-80A22F
100A	17-8100	FWP-100A22F

Fuse Holder Part Number		
Fuse Rating	Watlow	Ferraz Shawmut
40A	17-5114	US141I
50A	17-5114	US141I
63A	17-5122	US221I
80A	17-5122	US221I
100A	17-5122	US221I

Combined Branch Protection and Semiconductor Fuses for Applications through 480VAC

Fuse Part Number		
Fuse Rating 125% of Load	Watlow	Cooper Bussman®
20A	0808-0325-0020	DFJ-20
30A	0808-0325-0030	DFJ-30
40A	0808-0325-0040	DFJ-40
50A	0808-0325-0050	DFJ-50
63A	0808-0325-0060	DFJ-60
80A	0808-0325-0080	DFJ-80
100A	0808-0325-0100	DFJ-100

Fuse Holder Part Number		
Fuse Rating	Watlow	Cooper Bussman®
20 and 30A	0808-0326-1530	CH30J1i
40 to 63A	0808-0326-3560	CH60J1i
80 and 100A	0808-0326-7010	J601001CR

Ordering Information

Part Number

①	②	③	④	⑤ ⑥	⑦ ⑧	⑨	⑩	⑪ ⑫
D	C	Phase	Cooling & Current Rating/Leg	Line & Load Voltage	Control	Alarm	User Manual	Custom Options

③ Phase	
1 =	1-phase, 1 controlled leg
2 =	3-phase, 2 controlled legs
3 =	3-phase, 3 controlled legs (use with four wire wye)
8 =	2 independent zones (control options C, K)
9 =	3 independent zones (control options C, K)

④ Cooling and Current Rating per Leg (see chart below)	
0 =	Natural convection standard DIN-rail or panel heat sink
1 =	Fan cooled 120VAC standard DIN-rail or panel heat sink
2 =	Fan cooled 240VAC standard DIN-rail or panel heat sink
3 =	Fan cooled 24VDC standard DIN-rail or panel heat sink
T =	Natural convection through-wall or cabinet heat sink (NEMA 4X)

⑤ ⑥ Line & Load Voltage	
02 =	24 to 48VAC (control options C, F, K)
12 =	100 to 120VAC (control options L, P, S)
20 =	200 to 208VAC (control options L, P, S)
24 =	100 to 240VAC (control options C, F, K): 230 to 240VAC (control options L, P, S)
27 =	277VAC (control options L, P, S)
40 =	400VAC (control options L, P, S)
48 =	480VAC (control options L, P, S)
60 =	277 to 600VAC (control options C, F, K): 600VAC (control options L, P, S)

⑦ ⑧ Control	
C0 =	4.5 to 32VDC input, contactor output
F0 =	4 to 20mA DC input, variable time-base output
K1 =	22 to 26VAC input, contactor output
K2 =	100 to 120VAC input, contactor output
K3 =	200 to 240VAC input, contactor output
L (0 to 5) =	Phase angle output with current limiting* (single-phase only)
P (0 to 5) =	Phase angle output* (single-phase only)
S (0 to 5) =	Single-cycle variable time-base output
	0 = 4 to 20mA input
	1 = 12 to 20mA input (options S only)
	2 = 0 to 20mA input
	3 = 0 to 5VDC input
	4 = 0 to 5VDC input
	5 = 0 to 10VDC input

* Not CE approved for conducted or radiated emissions.

⑨ Alarm	
0 =	No alarm
S =	Shorted SCR alarm (not available with control options L or P)
H =	Open-heater and shorted-SCR alarm (control option S only)

⑩ User Manual	
0 =	English
1 =	German
2 =	Spanish
3 =	French

⑪ ⑫ Custom Options	
00 =	Standard part
1X =	1-second soft start (control options P, L)
XX =	Any letter or number, custom options, labeling, etc.

DIN-A-MITE C Current Rating Table

Phase	Cooling	Current at 122°F (50°C)
1	0	55A
1	T	60A
1	1, 2, 3	75A
2, 8	0	40A
2, 8	T	46A
2, 8	1, 2, 3	65A
3, 9	0	30A
3, 9	T	35A
3, 9	1, 2, 3	55A

Watlow® and DIN-A-MITE® are registered trademarks of Watlow Electric Manufacturing Company.

UL® and C-UL® are registered trademarks of the Underwriter's Laboratories, Inc.

Cooper Bussmann® is a registered trademark of Cooper Bussmann, Inc.

Powered by Possibility

To be automatically connected to the nearest North American Technical Sales Office:

1-800-WATLOW2 • www.watlow.com
inquiry@watlow.com

International Technical Sales Offices:

Austria	+43 6244 20129 0	India	+91 40 6661 2700
China	+86 21 3532 8532	Italy	+39 02 458 8841
France	+33 1 41 32 79 70	Japan	+81 3 3518 6630
Germany	+49 7253 9400 0	Korea	+82 2 2169 2600

Mexico	+52 442 256 2200
Singapore	+65 6773 9488
Spain	+34 91 675 1292
Taiwan	+886 7 288 5168
UK	+44 115 964 0777