

PD7000

PROVU® Dual-Line 6-Digit Temperature Meter



PROVU®
SERIES

SUPER-BRIGHT LEDs
Our Brightest Display Ever 

MeterView Pro
USB Install 



TEMPERATURE

- J, K, T, E, R, S, B, N, C Thermocouples
- 100 or 1000 Ω Platinum, 10 Ω Copper, 120 Ω Nickel RTDs
- 1° or 0.1° Resolution
- Averages up to 10 RTD Sensors
- Automatic Cold Junction Compensation
- NEMA 4X, IP65 Front
- Universal 85-265 VAC or 12-24 VDC Input Power
- Large Dual-Line 6-Character Display, 0.60" & 0.46"
- Programmable Displays & Function Keys
- Optional SunBright Display Models for Outdoor Applications
- 2 or 4 Relays + Isolated 4-20 mA Output Options
- External 4-Relay & Digital I/O Expansion Modules
- RS-232, & RS-485 Serial Communication Options
- Modbus® RTU Communication Protocol Standard
- On-Board Digital Input
- Onboard USB and MeterView® Pro Programming Software

**PRECISION
DIGITAL** 

www.predig.com

PRECISION DIGITAL CORPORATION

PD7000 PROVu® Dual-Line 6-Digit Temperature Meter



UV Resistant
Sunlight Readable Models



Front Panel
NEMA 4X Rated



MeterView Pro

USB Install

Large
0.6" Digits

Rugged Front

Dual-Line
6-Character
Display

User Configurable
Display

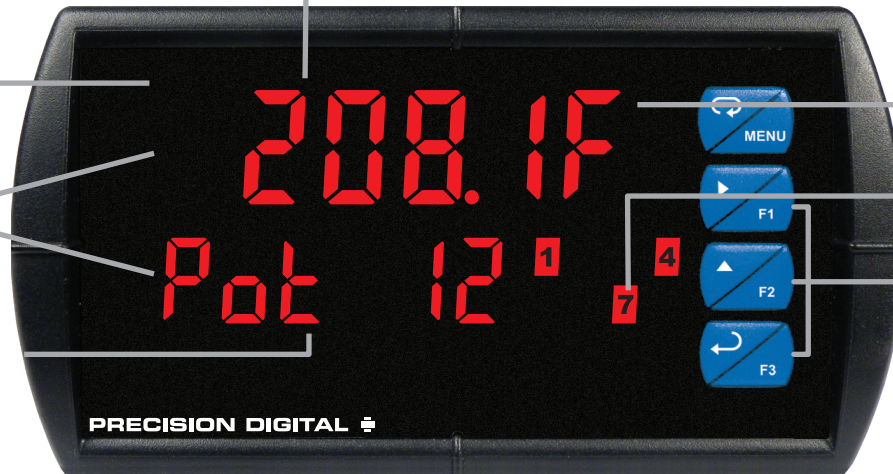

Temperature
Units

Alarm
Status Indicators

Programmable
Function Keys

PRECISION DIGITAL

INTRODUCTION

The PROVu PD7000 temperature meter boasts specifications and functionality that clearly makes it one of the most advanced temperature meters available. Its dual-line 6-character display, function keys, and optional expansion modules are only a few of the special features available on the PROVu.

Versatile

The PD7000 accepts many more thermocouple types and RTDs than earlier models. It can be configured to have either a 1° or 0.1° display resolution on any type of sensor input. The lower display makes configuration simpler. The display itself is quite configurable. There are many relay functions for up to 8 relays; including an Interlock Relay function. The 4-20 mA output can represent up to 12 different parameters/variables. This makes the PD7000 one of the most versatile meters on the market.

FRONT PANEL DISPLAY

Precise, Accurate, and More Informative

PROVu's large 0.6" upper display provides an accurate and precise 4 or 5-digit view of the temperature measurement.

Configurable

The upper display can be programmed to indicate current temperature, maximum or minimum temperature, alternating maximum/minimum temperatures, one of eight alarm set points, or Modbus input. The lower display can also be configured to display engineering units, set points, user defined legends, or simply turned off.

Function Keys

There are three function keys available to the user. These keys can be programmed to trigger certain events (i.e. acknowledge alarms, reset max and/or min, disable/enable output relays, or hold current relay states), provide direct menu access points, and more.

Learn more about using the PROVu's Function Keys by watching a video at predig.com/videos

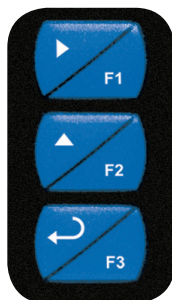

Standard LED and Optional SunBright LED Display Models

The PROVu's standard and SunBright display models feature extraordinarily bright LED displays. They are perfect for indoor and outdoor applications where visibility may be impaired by smoke, fog, dust, or distance. The intensity on the SunBright display model is so high it can be read even in the brightest sunlight.

Free USB Programming Software & Cable

The PROVu® comes preloaded with free **MeterView® Pro** programming software that connects and installs directly to your PC with a standard USB cable, also provided free with each instrument. This eliminates the need to insert CDs, install drivers, or download software from the internet. The software will allow you to configure, monitor, and datalog a PROVu® PD7000 using your PC. Just simply connect the meter to your PC with the USB cable and within minutes you will be programming it.

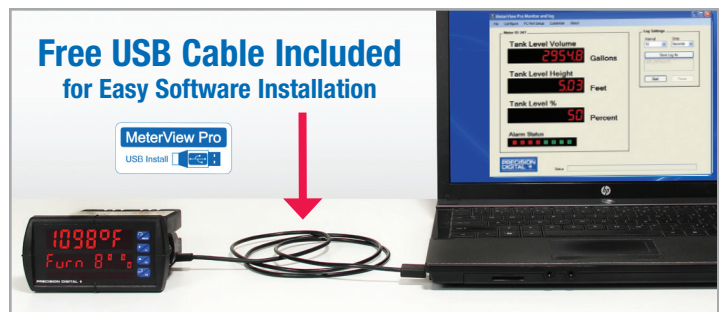

Easy to Use

The user friendly dual-line display makes the PROVu easy to set up & program. Input selection and configuration are conveniently set up via rear switches and front panel programming. Three levels of password protection help maintain the reliability of the programming.



Input Setup



Display Setup

PD7000 PROVU® Dual-Line 6-Digit Temperature Meter

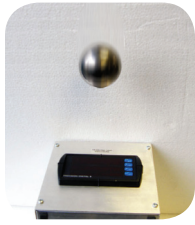

Rugged

A unique front panel design makes the PROVU nearly impenetrable in typical applications. Here, the PROVU easily survives a direct hit on the display from a heavy 2" solid stainless steel ball dropped from eight feet.

Three Tier Password Protection

The PROVU offers 3 levels of password protection:

- Level 1 protection allows the operator use of only the 3 pre-configured function keys on the front panel without a password.
- Level 2 protection allows the operator use of only the function keys and the ability to change set points without a password.
- Level 3 protection restricts the operator from using the function keys and all meter configuration menus without a password.

On-Board Digital Input

The PD7000 includes a digital input as standard. This digital input can operate with the tare, reset tare, or interlock relays feature, force relays on from a signal from a PLC or relay on other equipment, and much more. This is ideal for installations where the meter is inaccessible behind a cover, or where an additional function key is needed for customized operation.

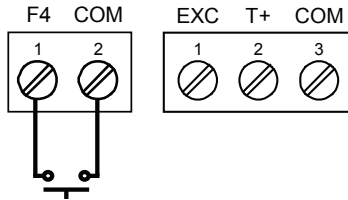

Rounding

The rounding feature is used to give the user a steadier display with fluctuating signals. It causes the display to round to the nearest value according to the rounding value selected (1, 2, 5, or 10). For example, with a rounding value of 10, and a input of 12346, the display would indicate 12350.

Max/Min Display

Max/Min (or Peak/Valley) is standard on the PROVU PD7000. Either display can be configured to show either maximum or minimum excursion since last reset. The displays can also be configured to toggle between Max and Min values. Both values can be simply reset from the front panel.

DIGITAL COMMUNICATIONS

Modbus® RTU Serial Communications

With the purchase of a serial communication adapter, PROVU meters can communicate with any Modbus Master device using the ever-popular Modbus communications protocol that is included in every PROVU. This greatly increases the flexibility of the meter. Modbus provides much more capability than read PV and write set points.



Modbus PV Input



Remote Message

MULTIPLE SENSOR AVERAGING

The PD7000 can find the average temperature of up to 10 RTD probes connected in parallel. This new calculated value would then be treated as the PV (temperature) displayed on the meter. The average temperature is also available via Modbus communications and as the retransmitted value for the optional 4-20 mA output.

METERVIEW® PRO SOFTWARE

Configure, monitor, and datalog a PD7000 from a PC using Meter View Pro Software (available with each PROVU meter via USB or for download at www.predig.com).

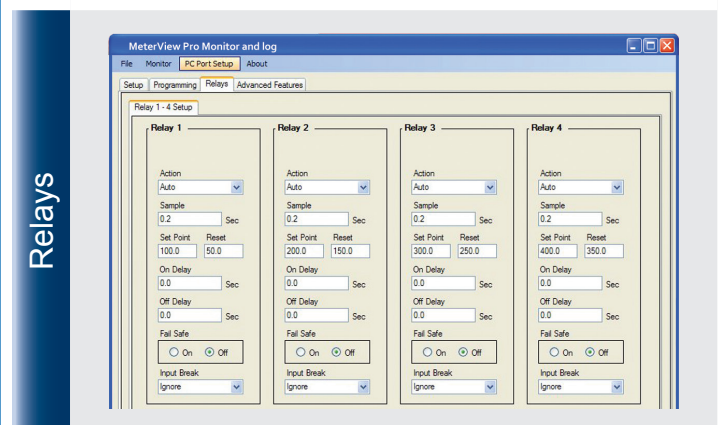
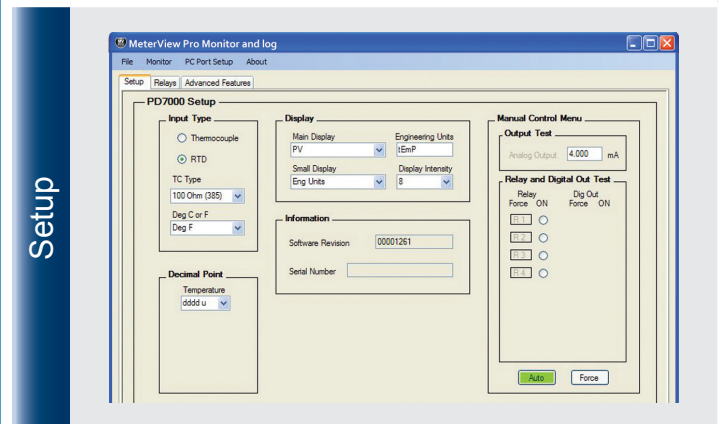
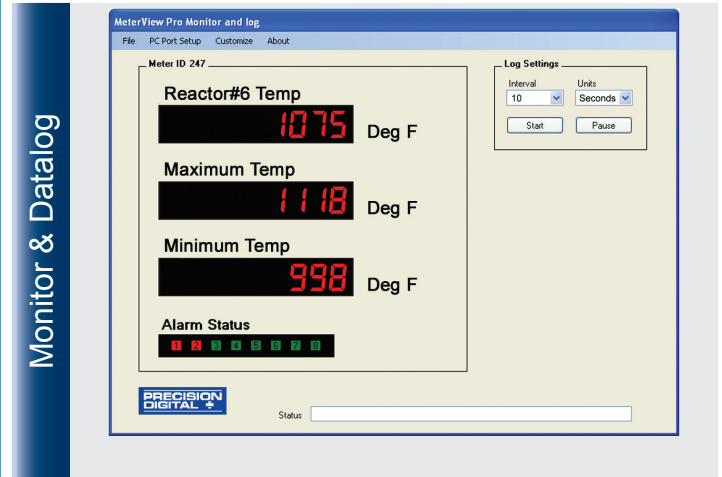

PD7000 PROVU® Dual-Line 6-Digit Temperature Meter

FIELD EXPANSION MODULES

Add functionality to the PROVU in the field with easy-to-install external expansion modules. Add RS-232 or RS-422/485 communications, I/O modules (up to 2), and 4-relay expansion module. The menu items for these modules do not appear until the module is connected, simplifying the basic menu. Relay and digital I/O modules are shown below with optional DIN rail mounting kit, P/N PDA1002.

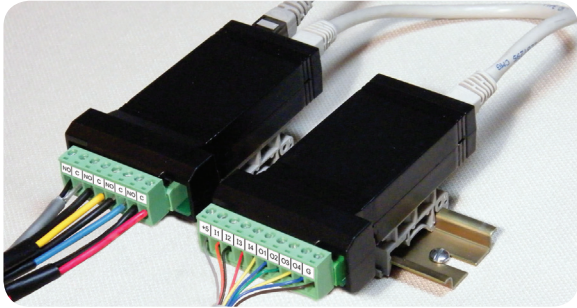

PDA1044 I/O Expansion Module

Four digital inputs and four digital outputs are available per expansion module. The PROVU meter will accept two of these modules. External digital inputs can function similarly to the front panel function keys or on-board digital input F4. They can be configured to trigger certain events (i.e. acknowledge/reset alarms, reset max and/or min values, disable/enable all output relays, and hold current relay states), provide direct menu access point, or mimic front panel keys. The I/O module can be used to configure the PROVU remotely, in essence giving the user control of the four front panel push buttons. This feature is particularly useful if the meter is mounted inside an explosion-proof enclosure.

Digital outputs can be used to remotely monitor PROVU's alarm relay output states, or the states of a variety of actions and functions executed by the meter.

PDA1004 Relay Expansion Module

An external module containing four 3 A Form A (SPST) relays can be added to the PROVU at anytime. Removable screw terminal blocks accept 12 to 22 AWG wire.

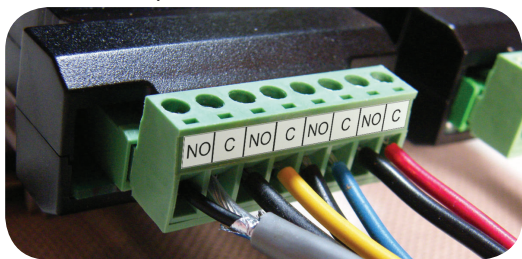

PDA1232 & PDA1485 Communication Modules

Serial communications on the PROVU can be added anytime with external PDA1232 (RS-232) or PDA1485 (RS-485) communication adapters.

Free Modbus protocol included for use with PROVU serial communications modules.



OUTPUTS

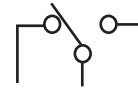

Relay Outputs

The PROVU has up to four 3 A Form C relays (SPDT) with multiple power loss fail-safe options. Relays can be configured for proper protective action upon input loop break. Relay ON and OFF delay times are user adjustable. Up to eight front panel indicators show alarm and/or relay state. All relays can be configured for 0-100% deadband.

Relay Operation/Configuration

There are powerful relay functions that can be configured in the PROVU meter, including:

- Automatic reset only (non-latching)
- Automatic + manual reset at any time (non-latching)
- Latching (manual reset only)
- Latching with clear (manual reset only after alarm condition has cleared)
- User selectable fail-safe operation
- Relay action upon sensor break
- Time delay (on and off), independent for each relay
- Manual control mode
- Interlock relay mode

Front panel button or digital input may be assigned to acknowledge relays programmed for manual reset.

Analog Output

The isolated analog retransmission signal can be configured to represent the measured temperature (including average temperature), maximum or minimum temperature, any of the eight relay set points, manual control setting, or Modbus input. While the output is nominally 4-20 mA, the signal will accurately accommodate under- and over-ranges from 1 to 23 mA. A power supply (24 V @ 40 mA) is standard with the 4-20 mA output option.

Manual Output Control

Take control of any output with this feature. All relays can be forced ON or OFF, and the 4-20 mA output signal can be set to any value within its range. When the relays and 4-20 mA output are controlled manually, an LED labeled "M" is turned on and the associated Alarm LEDs (1-8) flash every 10 seconds indicating that the meter is in manual control mode.



Interlock Relay(s)

This function allows a process to use one or more very low voltage input signals or simple switch contacts to control the state of one or more internal "interlock" relays. A violation (i.e. loss of input, open switch, or open circuit) forces one or more N/O interlock relay contacts to open. One input can be used in series with a number of interlock switches, or up to eight inputs can be required to force-on one (or more) internal interlock relays. Please see Application Note AN-1008 on our website for more information. Requires PDA1044 Digital I/O module or use of on-board digital input F4.

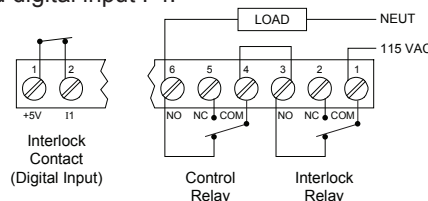

PD7000 PROVu® Dual-Line 6-Digit Temperature Meter

NEMA 4 & 4X FIELD ENCLOSURES

Thermoplastic and stainless steel NEMA 4X, and painted steel NEMA 4 enclosures for up to 10 PROVu meters are available. See our complete offering at www.predig.com/esu

PROTEX-MAX EXPLOSION-PROOF



All the proven features of the PROVu brought into your hazardous areas! Go to www.predig.com/pd8

PD8-7000
ProtEX-MAX Explosion-Proof

CONNECTIONS

- Form C (SPDT) relays
- Isolated supply available even on 12/24 VDC input power models
- Removable terminal blocks
- 2 or 4 relays + isolated 4-20 mA output option

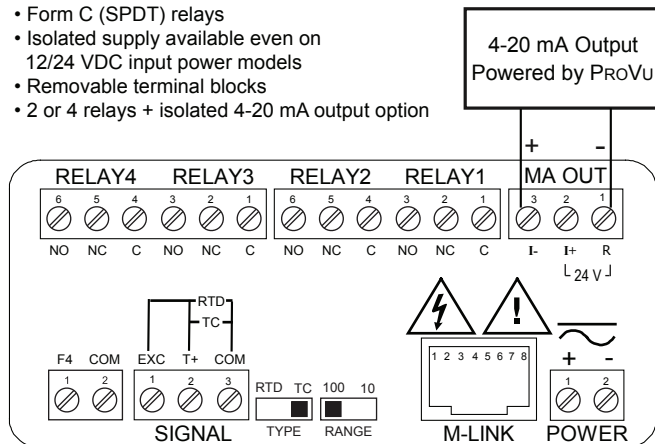

- Universal 85-265 VAC or 12/24 VDC input power
- Thermocouple or RTD inputs
- M-Link for adding expansion modules

DIMENSIONS

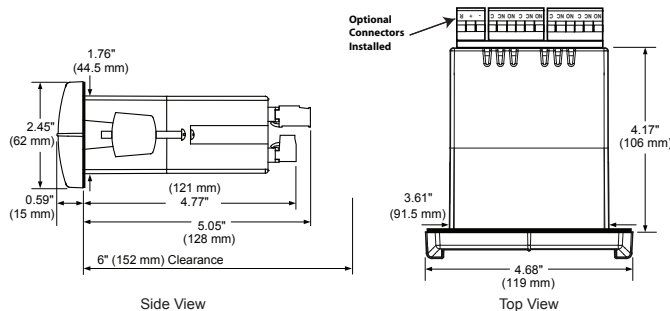

Notes:

1. Panel cutout required: 1.772" x 3.622" (45mm x 92mm)
2. Panel thickness: 0.040 - 0.250" (1.0mm - 6.4mm)
3. Mounting brackets lock in place for easy mounting
4. Clearance: Allow 6" (152 mm) behind the panel

SPECIFICATIONS

Except where noted all specifications apply to operation at +25°C.

General

Display: Upper display: 0.60" (15 mm) high. Lower display: 0.46" (12 mm) high. Both are 6 digits (-99999 to 999999), red LEDs.

Resolution: 1° (up to four digits) or 0.1° (up to five digits)

Display Intensity: Eight intensity levels

Display Update Rate: 5/second (200 ms)

Front Panel: NEMA 4X, IP65

Programming Methods: Four front panel buttons, digital inputs, PC and MeterView Pro software, Modbus registers, or cloning using Copy function.

F4 Digital Input Contacts: 3.3 VDC on contact. Connect normally open contacts across F4 to COM.

F4 Digital Input Logic Levels: Logic High: 3 to 5 VDC
Logic Low: 0 to 1.25 VDC

Noise filter: Programmable from 2 to 199 (0 will disable filter)

Filter Bypass: Programmable from 0.1 to 99.9% of span

Recalibration: Recommended at least every 12 months.

Max/Min Display: Max / min temperature readings are stored until reset by the user or until power to the meter is cycled.

Non-Volatile Memory: All programmed settings are stored in non-volatile memory for a minimum of ten years if power is lost.

Power Options: 85-265 VAC 50/60 Hz, 90-265 VDC, 20 W max, or optional model with 12-24 VDC ±10%, 15 W max.

Normal Mode Rejection: Greater than 65 dB at 50/60 Hz

Isolation: 4 kV input/output-to-power line. 500 V input-to-output

Environmental: Operating temperature range: -40 to 65°C

Storage temperature range: -40 to 85°C

Relative humidity: 0 to 90% non-condensing

Connections: Removable screw terminal blocks accept 12 to 22 AWG wire, RJ45 for external relays, digital I/O, and serial communication adapters.

Enclosure: 1/8 DIN, high impact plastic, UL 94V-0, color: black (92 mm x 45 mm). Two panel mounting bracket assemblies are provided.

Dimensions: 4.68" x 2.45" x 5.64" (119 mm x 62 mm x 143 mm) (W x H x D)

Weight: 9.5 oz (269 g)

UL File Number: UL & c-UL Listed. E160849; 508 Industrial Control Equipment.

Warranty: 3 years parts & labor

USB Connection: Compatibility: USB 2.0 Standard, Compliant

Connector Type: Micro-B receptacle

Cable: USB A Male to Micro-B Cable

Driver: Windows 98/SE, ME, 2000, Server 2003/2008, XP 32/64-Bit,

Vista 32/64-Bit, Windows 7 32/64-Bit, Windows 10 32/64-Bit

Power: USB Port

Temperature Input

Inputs: Thermocouple J, K, T, E, R, S, B, N, C; RTD 100 Ω platinum (0.00385 & 0.00392 curves), 10 Ω copper, 120 Ω nickel, 1000 Ω platinum

Input Impedance: Greater than 100 kΩ

Offset Adjust: User programmable offset adjust ±50.0 degrees

Temperature Drift: ±2°C maximum from 0 to 65°C ambient temperature; ±4°C maximum from -20 to 0°C ambient temperature

Sensor Break: Display flashes "Open", relays can be programmed to go "On", "Off", or to "Ignore" (detected as an upscale condition).

Averaging: Up to 10 RTDs connected in parallel can be averaged.

Accuracy & Range: See table below.

| Type | Range (°F) | Range (°C) | Accuracy |
|--------|--------------|--------------|----------|
| J | -200 to 2000 | -129 to 1093 | ±1°C |
| K | -200 to 2400 | -129 to 1316 | ±1°C |
| T | -200 to 752 | -129 to 400 | ±1°C |
| E | -200 to 1800 | -129 to 982 | ±1°C |
| R | -50 to 3000 | -46 to 1649 | ±2°C |
| S | -50 to 3000 | -46 to 1649 | ±2°C |
| B | 752 to 3300 | 400 to 1816 | ±2°C |
| N | -100 to 2300 | -73 to 1260 | ±2°C |
| C | 32 to 4100 | 0 to 2260 | ±2°C |
| 10 Ω | -328 to 500 | -200 to 260 | ±0.1°C |
| 100 Ω | -328 to 1562 | -200 to 850 | ±0.4°C |
| 120 Ω | -110 to 500 | -79 to 260 | ±0.1°C |
| 1000 Ω | -328 to 900 | -200 to 482 | ±0.4°C |

PD7000 ProVu® Dual-Line 6-Digit Temperature Meter

Relays

Rating: 2 or 4 SPDT (Form C) internal and/or 4 SPST (Form A) external; rated 3 A @ 30 VDC and 125/250 VAC resistive load; 1/14 HP (≈ 50 watts) @ 125/250 VAC for inductive loads such as contactors, solenoids, etc.

Noise Suppression: Noise suppression is recommended for each relay contact switching inductive loads.

Deadband: 0-100% of span, user programmable

High or Low Alarm: User may program any alarm for high or low trip point. Unused alarm LEDs and relays may be disabled (turned off).

Relay Operation: automatic (non-latching), latching (requires manual acknowledgement), sampling (based on time), pump alternation control (2 to 8 relays), Off (disable unused relays and enable interlock feature, manual on/off control mode).

Time Delay: 0 to 999.9 seconds, on & off relay time delays. Programmable and independent for each relay.

Fail-Safe Operation: Programmable and independent for each relay.

Note: Relay coil is energized in non-alarm condition. In case of power failure, relay will go to alarm state.

Auto Initialization: When power is applied to the meter, relays will reflect the state of the input to the meter.

Isolated 4-20 mA Transmitter Output

Output Source: PV (temperature), max, min, set points 1-8, manual control setting, or Modbus input

Scaling Range: 1.000 to 23.000 mA for any display range

Calibration: Factory calibrated 4-20 mA output

Accuracy: ± 0.1% of span ± 0.004 mA

Temperature Drift: 0.4 µA/°C max from 0 to 65°C ambient, 0.8 µA/°C max from -40 to 0°C ambient

Note: Analog output drift is separate from input drift.

Isolated Transmitter Power Supply: Terminals I+ & R: 24 VDC ± 10%. Isolated from the input at >500 V. May be used to power the 4-20 mA output or other devices. All models rated @ 40 mA max.

External Loop Power Supply: 35 VDC maximum

Output Loop Resistance:

| Power supply | Minimum | Maximum |
|-------------------|---------|---------|
| 24 VDC | 10 Ω | 700 Ω |
| 35 VDC (external) | 100 Ω | 1200 Ω |

Serial Communications

Protocol: Modbus® RTU

Meter Address/Slave ID: 1 - 247

Baud Rate: 300 - 19,200 bps

Transmit Time Delay: Programmable between 0 and 199 ms or transmitter always on for RS-422 communication

Data: 8 bit (1 start bit, 1 or 2 stop bits)

Parity: Even, odd, or none with 1 or 2 stop bits

Byte-to-Byte Timeout: 0.01 - 2.54 seconds

Turn Around Delay: Less than 2 ms (fixed)

Note: Refer to the ProVu® Modbus Register Tables located at www.predig.com for details.

Digital I/O Expansion Module

Channels: 4 digital inputs & 4 digital outputs per module

System: Up to 2 modules for a total of 8 inputs & 8 outputs

Digital Input Logic: High: 3 to 5 VDC **Low:** 0 to 1.25 VDC

Digital Output Logic: High: 3.1 to 3.3 VDC **Low:** 0 to 0.4 VDC

Source Current: 10 mA maximum

Sink Current: 1.5 mA minimum

+5 V Terminal: To be used as pull-up for digital inputs only.

4-Relay Expansion Module

Relays: Four Form A (SPST) rated 3 A @ 30 VDC and 125/250 VAC resistive load; 1/14 HP (≈ 50 watts) @ 125/250 VAC for inductive loads.

ORDERING INFORMATION

| ProVu® PD7000 • Standard Models | | |
|---------------------------------|-----------------|---------------------------|
| 85-265 VAC Model | 12-24 VDC Model | Options Installed |
| PD7000-6R0 | PD7000-7R0 | None |
| PD7000-6R2 | PD7000-7R2 | 2 Relays |
| PD7000-6R3 | PD7000-7R3 | 4-20 mA Output |
| PD7000-6R4 | PD7000-7R4 | 4 Relays |
| PD7000-6R5 | PD7000-7R5 | 2 Relays & 4-20 mA Output |
| PD7000-6R7 | PD7000-7R7 | 4 Relays & 4-20 mA Output |

| ProVu® PD7000 • SunBright Display Models | | |
|--|-----------------|---------------------------|
| 85-265 VAC Model | 12-24 VDC Model | Options Installed |
| PD7000-6H0 | PD7000-7H0 | None |
| PD7000-6H2 | PD7000-7H2 | 2 Relays |
| PD7000-6H3 | PD7000-7H3 | 4-20 mA Output |
| PD7000-6H4 | PD7000-7H4 | 4 Relays |
| PD7000-6H5 | PD7000-7H5 | 2 Relays & 4-20 mA Output |
| PD7000-6H7 | PD7000-7H7 | 4 Relays & 4-20 mA Output |

| Accessories | |
|-------------|---|
| Model | Description |
| PDA1002 | DIN Rail Mounting Kit for Two Expansion Modules |
| PDA1004 | 4-Relay Expansion Module |
| PDA1044 | 4 Digital Inputs & 4 Digital Outputs Module |
| PDA1232 | RS-232 Serial Adapter |
| PDA1485 | RS-422/485 Serial Adapter |
| PDA7485-I | RS-232 to RS-422/485 Isolated Converter |
| PDA7485-N | RS-232 to RS-422/485 Non-Isolated Converter |
| PDA8232-N | USB to RS-232 Non-Isolated Converter |
| PDA8485-I | USB to RS-422/485 Isolated Converter |
| PDA8485-N | USB to RS-422/485 Non-Isolated Converter |
| PDX6901 | Suppressor (snubber): 0.01 µF/470 Ω, 250 VAC |

Your Local Distributor is:

Disclaimer

The information contained in this document is subject to change without notice. Precision Digital Corporation makes no representations or warranties with respect to the contents hereof, and specifically disclaims any implied warranties of merchantability or fitness for a particular purpose.

©2010-2016 Precision Digital Corporation. All rights reserved.

LDS7000_E 05/16

PRECISION DIGITAL CORPORATION

233 South Street • Hopkinton MA 01748 USA • Tel (800) 343-1001 • Fax (508) 655-8990

**PRECISION
DIGITAL**
www.predig.com